

version .0

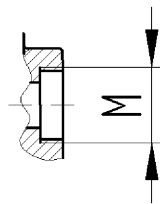
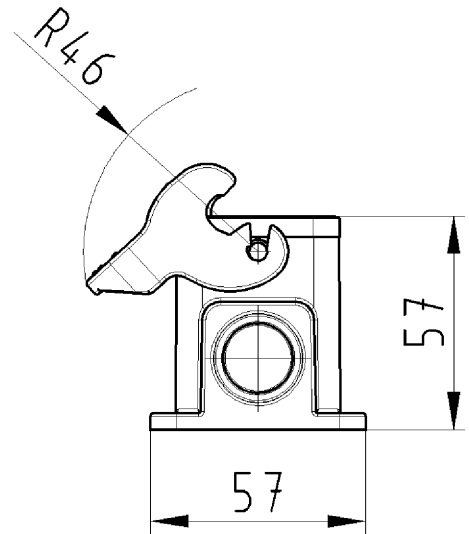
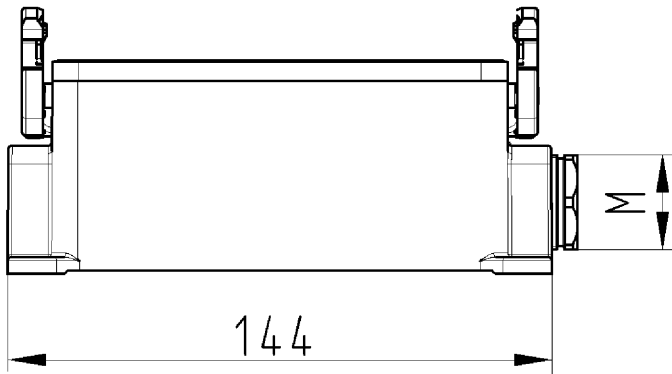

version .1

Gehäuseunterteil
71.331.2435.0

Zeichnungsnummer
71.331.2435.010W
Gehäuseunterteil

11.12.2007
Hoffmann Angelika
M 1:2